



SWITCHING POWER SUPPLY SPECIFICATION

CP-83035

CLAYPOWER
C O M P A N Y

REV.00

- 1.0 General**
- 1.1 Parameter Specifications**

- 2.0 Input Characteristics**
- 2.1 Input Voltage**
- 2.2 Input Waveform**
- 2.3 Input Frequency**
- 2.4 Input Current**
- 2.5 In-Rush Current**
- 2.6 Line Regulation**
- 2.7 Input Leakage Current**
- 2.8 Dielectric Withstand Voltage**
- 2.9 Insulation Resistance**

- 3.0 Output Characteristics**
- 3.1 DC Output Characteristics**
- 3.2 Overshoot**
- 3.3 Efficiency**

- 4.0 Time Sequence**
- 4.1 Hold-Up time**
- 4.2 Power Good Signal**
- 4.3 +5V Volt and Power Good Output Rise Time**
- 4.4 Start-Up Time**
- 4.5 Dynamic Load Response Time**

- 5.0 Protection**
- 5.1 Over Power Protection**
- 5.2 Over Voltage Protection**
- 5.3 Short Circuit Protection**
- 5.4 No Load Operation**

- 6.0 System Interface Signal**
- 6.1 Power System Fault Signal**
- 6.2 Alarm Beeping Sound**

- 7.0 Physical Characteristics**
 - 7.1 Size**
 - 7.2 Mounting Requirements**
 - 7.3 Cooling**

- 8.0 Connectors**
 - 8.1 DC Output Wire List**
 - 8.2 AC Input**

- 9.0 Environmental**
 - 9.1 Temperature**
 - 9.2 Relative Humidity**
 - 9.3 Altitude**
 - 9.4 Shock**
 - 9.5 Vibration**
 - 9.6 Power Line Transient**
 - 9.7 Acoustic Noise**

- 10.0 Regulatory Agency Certification**
 - 10.1 RFI/EMI Standards**
 - 10.2 Safety Standards**

- 11.0 Reliability**
 - 11.1 Mean Time Between Failures(MTBF)**
 - 11.2 Warranty**

1.0 General

This specification describes the physical, functional and electrical Characteristics of a redundancy 350+350 watts. 6-output, fan-cooled switching power supplies.

1.1 Parameter Specification

Unless specification otherwise, all parameters must be meet over the limits of temperature, load and input voltage.

2.0 Input Characteristics

2.1 Input Voltage:

90Vac To 264Vac, With Active Power Factor ,PF=90% Min.

2.2 Input Waveform

The unit is capable of operating with 10% distorted sine wave input. It is measured by a distortion analyzer. Its flat-topping clipped 10% from the peak value of standard sine-wave.

2.3 Input Frequency

47 – 63Hz

2.4 Input current

7.0A/4A (One Power Supply)

2.5 In-Rush Current

CONDITION

132/264Vac, Full load.
Turn off 1 sec; turn on at
peak of input voltage cycle.
25°C Air Ambient cold start.

LIMITS

No damage shall occur or
components over stressed,
Input Fuse shall not blow.

2.6 Line Regulation

CONDITION

Full Load 90Vac To 264Vac,
With Active Power Factor ,PF=90% Min.

LIMITS

1%

2.7 Input Leakage Current

Input leakage current from line to frame ground will be less than 3.5mA rms. for each power module. Condition: 264Vac/60Hz

2.8 Dielectric Withstand Voltage

Primary to Secondary : 1500V ac / 50Hz for 1 Minute.

Primary to Safety Ground: 1500V ac / 50Hz for 1 Minute.

2.9 Insulation Resistance

Primary to Safety Ground : 500Vdc, 50Mohms Minimum.

3.0 Output Characteristics

3.1 DC Output Characteristics

To be met under all combinations of loading.

Output voltage	V1 +5V	V2 +3.3V	V3 +12V	V4 -5V	V5 -12V	Vsb +5V
Max Load	30A	28A	20A	1A	1A	1.5A
Min Load	2A	0.2A	0.5A	0A	0A	0A
Load Reg. %	+/-5%	+/-5%	+/-5%	+/-10%	+/-10%	+/-5%
Cross Reg. 60%	+/-5%	+/-5%	+/-5%	+/-10%	+/-10%	+/-5%
Line Reg. %	+/-1%	+/-1%	+/-1%	+/-1%	+/-1%	+/-1%
Ripple Reg. mV	50mV	50 mV	120 mV	100 mV	200 mV	100 mV
Noise Reg. mV	100mV	70mV	150mV	200mV	200mV	100mV

Note1: Noise bandwidth is from DC to 20MHz. Add 0.1uF/10uF Capacitor at output connector terminals for Ripple And Noise measurement.

Note2: Regulation tolerance shall include temperature change, warm up drift and dynamic load.

Note3: Combined Total Power from +3.3V and +5V Rails Shall Not Exceed 160W.

Note4: The Total Output Power Shall Not exceeds 350W.

3.2 Overshoot

Any output overshoots at TURN-ON shall not exceed 10% (+5V/+12V output) and 10% (-5V/-12V output) of nominal voltage value.

3.3 Efficiency

58% min. at full load test.

4.0 Time Sequence

4.1 Hold-Up Time

Unit shall continue to supply regulated DC outputs and power good signal for at least 16 Milliseconds at 115/230Vac full load after a loss of AC input voltage which shall be represented by a short circuit at the AC input. See Figure 2.

4.2 Power Good Signal

When the power supply is turned off a minimum of 1.0 second and turned on, the power-good signal as described below will be generated.

The power supply shall provide a power-good signal to indicate proper operation of the power supply. This signal shall be a TTL compatible high level for normal operation; low level for fault conditions.

Power-good shall go to low level at least 1 ms before the +5V output voltage falls below the regulation limits described in 3.1 DC output Characteristics.

The operation point used as a reference for measuring the 1ms shall be minimum line voltage and maximum load.

All waveform transitions shall be smooth and monotony, i.e. no oscillations.

The power-good signal shall stay low (during POWER-ON) until all output voltages are delay greater than 100ms but less than 500ms. See Figure 2.

4.2.1 Fan out

Power Good output circuit shall consist of an active pull down component and a passive pull up resistor.

Power-Good output voltage to be met under recommended loading conditions.

CONDITION

$I_{OH} = -140\mu A$ Min.

$I_{OL} = 2.8mA$ Min.

LIMITS

$V_{OH} = 2.7V$ Min.

$V_{OL} = 0.4V$ Min.

4.3 +5V Volt and Power Good Output Rise Time

4.3.1 + 5 Volt Output Rise Time

The +5V output shall have a turn-on rise time of less than 100ms under all load conditions. Rise time is measured between 0.0 and 4.75V.

The +5V output shall not vary from a smooth curve by more than $0.5V_{p-p}$ during turn-on and turn-off.

4.3.2. Power Good Output Rise

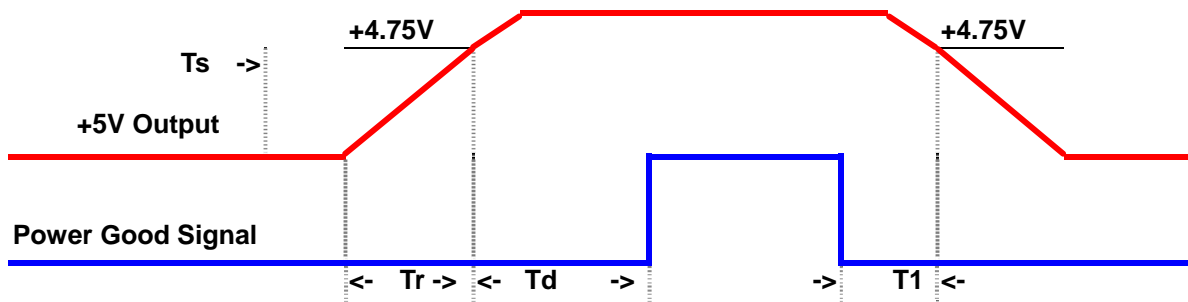

Note: $T_r \leq 100$ ms, $T_1 \geq 1$ ms, $T_d = 100 - 500$ ms.

4.4 Start-Up timing

All output shall be stable and in regulation in less than 2.0 second under all load and line condition. Start-up time is measured between the AC turn-on and 4.75V on +5V See Figure 2.

4.5 Dynamic Load Response Time

Transient response is measured by switching the output load from 80 to 100 to 80 percent of its full value at a frequency of 100Hz and 50% duty cycle, step load change is $0.5A/\mu s$, The magnitude V_r is less than $\pm 5\%$ of +5V and +12V output, the recovery time T_r is less than 1mS. See Figure3.

5.0 Protection

5.1 Over Power Protection

This power supply shut down all DC output when outputs are overloaded to the limit. The power supply logic shall latch into the off state requiring a power on cycle to be performed by the operator. The power supply will turn-off within 20ms of the occurrence of the overload.

<u>CONDITION</u>	<u>LIMITS</u>
Nominal input	When output power is over to 110% ~ 150%

5.2 Over Voltage Protection

The power supply shall latch off if the +5VDC or +12VDC or +3.3VDC maximum voltage exceeds the limits shown. The AC must be recycled to restart.

5.2.1 + 5VDC

<u>CONDITION</u>	<u>LIMITS</u>
All operating	Max.6.8Vdc

5.2.2 +3.3VDC

<u>CONDITION</u>	<u>LIMITS</u>
All operating	Max.4.50Vdc

5.2.3 +12VDC

<u>CONDITION</u>	<u>LIMITS</u>
All operating	Max.15Vdc

5.3 Short Circuit Protection

A short circuit placed on any output shall cause no damage to this unit. The power supply shall be shut down.

5.4 No Load Operation

When primary power is applied, with no load on any output voltage, no damage or hazardous condition shall occur. In such a case, the power supply shall power up and stabilize.

6.0 System Interface Signal

6.1 Power System Fault Signal

The Hot-Swap Redundant Power Supply shall give fault signal (an open collector) that will indicate the status of the power supply operation. If one of the power supply unit shut down, the power fault signal could be generated. This signal shall be high level for normal operation; Low level for

fault conditions.

6.2 Alarm Beeping Sound

The alarm system monitors the power supply failure and provides alarm to indicate the status of the power supply. By checking the LED on the power supply, end users will be able to locate the defective power unit. The alarm system will give a beeping sound to indicate the power supply failure until that particular power unit is replaced.

Beeping sound could be suspended before the failure power supply unit replaced.

7.0 Physical Characteristics

7.1 Size

See Figure1

7.2 Mounting Requirements

See Figure1

7.3 Cooling

BY BALL-BEARING FAN.

8.0 Connections

8.1 DC Output Wire List

<u>Connector</u>	<u>Output</u>	20 P	<u>Wire Color</u>	<u>Wire Size</u>
P1-1	+3.3V		Brown	18 AWG
P1-1-1	+3.3V Sense		Brown	22 AWG
P1-2	+3.3V		Brown	16 AWG
P1-3	COM		Black	18 AWG
P1-3-1	+3.3VCOM Sense		Black	22 AWG
P1-4	+5V		Red	18 AWG
P1-4-1	+5V Sense		Red	22 AWG
P1-5	COM		Black	16 AWG
P1-6	+5V		Red	16 AWG
P1-7	COM		Black	18 AWG

P1-8	POK	Orange	16 AWG
P1-9	+5VSB	Purple	16 AWG
P1-10	+12V	Yellow	18 AWG
P1-10-1	+12V Sense	Yellow	22 AWG
P1-11	+3.3V	Brown	16 AWG
P1-12	-12V	Blue	16 AWG
P1-13	COM	Black	16 AWG
P1-14	PS-ON	Green	16 AWG
P1-15	COM	Black	16 AWG
P1-16	COM	Black	16 AWG
P1-17	COM	Black	16 AWG
P1-18	-5V	White	16 AWG
P1-19	+5V	Red	16 AWG
P1-20	+5V	Red	18 AWG

<u>Connector</u>	<u>Output</u>	H 4P	<u>Wire Color</u>	<u>Wire Size</u>
P2~P8-1	+12V		Yellow	18 AWG
P2~P8-2	COM		Black	18 AWG
P2~P8-3	COM		Black	18 AWG
P2~P8-4	+5V		Red	18 AWG

<u>Connector</u>	<u>Output</u>	L 4P	<u>Wire Color</u>	<u>Wire Size</u>
P9-1	+12V		Yellow	20 AWG
P9-2	COM		Black	20 AWG
P9-3	COM		Black	20 AWG
P9-4	+5V		Red	20 AWG

PS1 LED	<u>Connector</u>	<u>Output</u>	GREEN LED	<u>Wire Color</u>	<u>Wire Size</u>
				GREEN	22 AWG
				BLACK	22 AWG

PS2 LED	<u>Connector</u>	<u>Output</u>	GREEN LED	<u>Wire Color</u>	<u>Wire Size</u>
				PURPLE	22 AWG
				BLACK	22 AWG

REMOTE ON/OFF	<u>Connector</u>	<u>Output</u>	<u>Wire Color</u>	<u>Wire Size</u>
			WHITE	22 AWG
			BLACK	22 AWG

TTL	<u>Connector</u>	<u>Output</u>		<u>Wire Color</u>	<u>Wire Size</u>
				BLUE	22 AWG
				BLACK	22 AWG
P/S FAIL	<u>Connector</u>	<u>Output</u>	GREEN LED	<u>Wire Color</u>	<u>Wire Size</u>
				GRAY	22 AWG
				BLACK	22 AWG
P/S GOOD	<u>Connector</u>	<u>Output</u>	GREEN LED	<u>Wire Color</u>	<u>Wire Size</u>
				ORANGE	22 AWG
				BLACK	22 AWG
STB ON	<u>Connector</u>	<u>Output</u>	GREEN LED	<u>Wire Color</u>	<u>Wire Size</u>
				BROWN	22 AWG
				BLACK	22 AWG
Reset S.W.	<u>Connector</u>	<u>Output</u>		<u>Wire Color</u>	<u>Wire Size</u>
				Yellow	22 AWG
				Black	22 AWG

8.2 AC Input

IEC-320 power inlet.
(Optional)

9.0 Environmental

9.1 Temperature

9.1.1 Operating

50 to 122°F (10 to 50°C). De-rate Linearly to 50% at 70°C

9.1.2 Non-Operating

-4.0 to 140°F (-20 to 60°C)

9.2 Relative Humidity

9.2.1 Operating

20 to 90 % non-condensing at 104°F (40°C).

9.2.2 Non-Operating

5 to 95 % non-condensing at 122°F (50°C)

9.3 Altitude**9.3.1 Operating**

Sea level to 10,000feet.

9.3.2 Non-Operating

Sea Level to 40,000 feet.

9.4 Shock**9.4.1 Operating**

The power supply shall exhibit no signs of damage or degradation of performances when subjected to a shock of 5g's for 11 ms, with 1 1/2 sine wave for each of the perpendicular axes X,Y and Z.

9.4.2 Non-Operating

The power supply shall exhibit no signs of damage or degradation of performances when subjected to a shock of 30g's for 11 ms, with 1 1/2 sine-wave for each of the perpendicular axes X, Y and Z.

9.5 Vibration**9.5.1 Operating**

The power supply shall be subjected to a vibration test consisting of a 10 to 500Hz sweep at a constant acceleration of 0.5g for a duration of one (1) Hour for each of the perpendicular axes X, Y and Z.

The output voltage shall remain within specification.

9.5.2 Non-Operating

The power supply shall be subjected to a vibration test consisting of a 10 to 300Hz sweep at a constant acceleration of 2.0g for a duration of one (1) hour for each of the perpendicular axes X, Y and Z.

The power supply shall not incur physical damage or degradation of any characteristics below the performance specifications.

9.6 Power Line Transient

9.6.1 Drop out

With a full cycle input voltage drop-out at 50 Hz, the power supply shall operating within the prescribed voltages whita a drop-out cycle repetition rate of 500ms.

CONDITIONS

Full load, Nom. AC voltage Input

LIMITS

Meet all requirements

9.6.2 Transient Voltage Spikes

The unit shall meet the following standards, The IEEE Standard 587-1980 for surge withstand capability under categories A and B. The crest value of the first half peak of the injected Ring-wave (0.5/10us) Bi-wave (1.2/50us) will be 3k volts open circuit and 3KA (8us X 20us) short circuit.

IEC 801–2 (ESD) to a level of 8KV contact, and 15K air discharge without causing the device(s) to fail the test.

IEC 801-4 (EFT) on the power lines and all I/O cables to a level of 2.5KV Without causing the Device(s) to fail the test.

IEC 801-5 Surge immunity measurement on the input power source of 2.5KV. All output shall be stable and in regulation.

9.7 Acoustic Noise

The power supply shall be tested in accordance with the ANSIS12.10-1985 standard specification. The “A” weighted overall sound pressure level as well as individual octave band levels from 63Hz to 16,000Hz is measured with the noise meter placed 1 meter from the nearest vertical surface of center of fan installed in power supply.

CONDITION

115VAC Input, full load of +5V
0.5A of +12V

LIMITS

Acoustic noise is 40db maximum

Octave Band Center Frequency (Hz)								A-Weighted
125	250	500	1k	2k	4k	8k	16k	Max. Sum
20	36	42	42	42	36	30	20	40Dba

10.0 Regulatory Agency Certification

10.1 RFI/EMI Standards

The power supply, When installed in system, shall comply with the following

Radiated and conducted emissions standards:

- (1) FCC part 15, Subpart B, Class B computing device.
- (2) CISPR22 (EN55022) Class B.
- (3) VCCI Class 2.

These limits shall be met with a margin of at less 6dB at all applicable frequencies. The units shall comply with the above limits when tested under all normal working conditions and with all interface cables connected.

10.2 Safety Standard

The power supply shall be certified with the following safety standards,

- (1) UL 1950 (Information Processing / Business equipment).
- (2) c-UL
- (3) TUV Certification to IEC950 1 edition with Amendment#1, #2, and EN60950
- (4) CE Certificate & Test Report.
- (5) Harmonic Requirement ---IEC10000-3-2 & IEC10000-3-3 Class " D ".

11.0 Reliability

11.1 Mean Time Between Failure(MTBF)

Using MIL 217E the calculated MTBF=100,000 hours at 25°C 75% loading.

11.2 Warranty

Two (2) years manufacture's warranty.

REVISIONS			
NO	DESCRIPTION	DATE	APPROVED

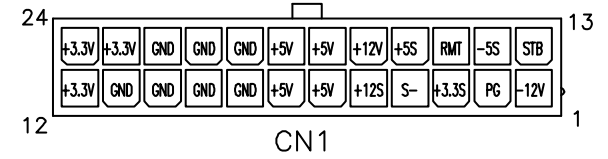
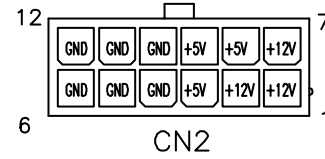
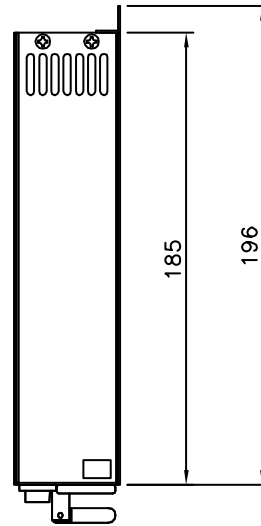
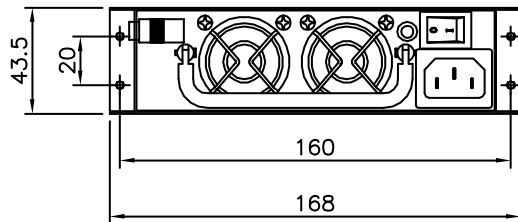
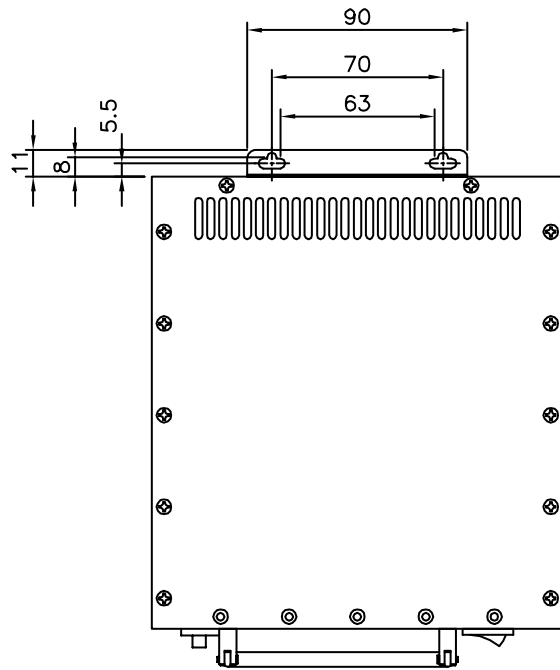
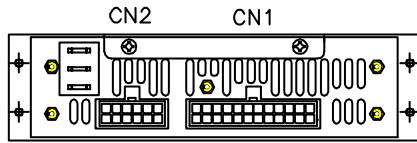

CLAYPOWER COMPANY					
APPROVED	DATE	TITLE CP-83035			
CHECKED	DATE	DRAWING NO. 1PRA350MV5-A0	PART NO. 1PRA350MV5	REV. A0	
DESIGNED LSS	DATE 05/27/08	SCALE : MM(INCHES) 1:4	TOLERANCES: .XX = ±.10 .XXX = ±.05	MODEL NO. 昱辰	SHEET 1of1

第三角法 (Projection)	FINISH:	MATERIAL:
	採購	生產
	品管	